

# **LQ084V1DG21**

## **TFT-LCD Module**

Spec. Issue Date: July 13, 2005

No: LCY-02131A

PREPARED BY : DATE

*C. Murata : Jul. 13, 2005*

APPROVED BY : DATE

*S. Komaki : Jul. 13, 2005*

# SHARP

SHARP CORPORATION

## SPECIFICATION

SPEC No. LCY-02131A

FILE No.

ISSUE : Jul. 13, 2005

PAGE : 18 pages

APPLICABLE GROUP :  
MOBILE LIQUID CRYSTAL  
DISPLAY GROUP

DEVICE SPECIFICATION FOR

# TFT-LCD Module

MODEL No.

# LQ084V1DG21

CUSTOMER'S APPROVAL

DATE

BY

PRESENTED

BY *Hiroshi Hamada*

H. HAMADA

DEPARTMENT GENERAL MANAGER

ENGINEERING DEPT. I

MOBILE LCD DESIGN CENTER I

MOBILE LIQUID CRYSTAL DISPLAY GROUP

SHARP CORPORATION



**NOTICE**

This publication is the proprietary of SHARP and is copyrighted, with all rights reserved. Under the copyright laws, no part of this publication may be reproduced or transmitted in any form or by any means, electronic or mechanical for any purpose, in whole or in part, without the express written permission of SHARP. Express written permission is also required before any use of this publication may be made by a third party.

The application circuit examples in this publication are provided to explain the representative applications of SHARP's devices and are not intended to guarantee any circuit design or permit any industrial property right or other rights to be executed. SHARP takes no responsibility for any problems related to any industrial property right or a third party resulting from the use of SHARP's devices, except for those resulting directly from device manufacturing processes.

In the absence of confirmation by device specification sheets, SHARP takes no responsibility for any defects that occur in equipment using any of SHARP's devices, shown in catalogs, data books, etc. Contact SHARP in order to obtain the latest device specification sheets before using any SHARP's device.

SHARP reserves the right to make changes in the specifications, characteristics, data, materials, structures and other contents described herein at any time without notice in order to improve design or reliability. Contact SHARP in order to obtain the latest specification sheets before using any SHARP's device. Manufacturing locations are also subject to change without notice.

Observe the following points when using any device in this publication. SHARP takes no responsibility for damage caused by improper use of the devices.

The devices in this publication are designed for general electronic equipment use.

The appropriate design measures should be taken to ensure reliability and safety when SHARP's devices are used for equipment such as:

- Transportation control and safety equipment (i.e., aircraft, trains, automobiles, etc.)
- Traffic signals • Gas leakage sensor breakers • Alarm equipment • Various safety devices etc.

SHARP's devices shall not be used for equipment that requires extremely high level of reliability, such as:

- Military and space applications      • Nuclear power control equipment
- Medical equipment for life support

Contact a SHARP representative, in advance, when intending to use SHARP's devices for any "specific" applications other than those recommended by SHARP.

Contact and consult with a SHARP representative if there are any questions about the contents of this publication.

### 1. Application

This specification applies to color TFT-LCD module, LQ084V1DG21.

### 2. Overview

This module is a color active matrix LCD module incorporating amorphous silicon TFT (Thin Film Transistor). It is composed of a color TFT-LCD panel, driver ICs, control circuit and power supply circuit and a backlight unit. Graphics and texts can be displayed on a  $640 \times 3 \times 480$  dots panel with 262,144 colors by supplying 18 bit data signals (6bit/color), four timing signals, +3.3V/ +5V DC supply voltage for TFT-LCD panel driving and supply voltage for backlight.

The TFT-LCD panel used for this module is a low-reflection and higher-color-saturation type. Therefore, this module is also suitable for the multimedia use. Optimum viewing direction is 12 o'clock.

This module is the type of wide viewing angle and high brightness( $300\text{cd/m}^2$ ).

Backlight-driving DC/AC inverter is not built in this module.

### 3. Mechanical Specifications

Parameter	Specifications	Unit
Display size	21 (8.4") Diagonal	cm
Active area	170.9(H) $\times$ 129.6(V)	mm
Pixel format	640(H) $\times$ 480(V)	pixel
	(1 pixel=R+G+B dots)	
Pixel pitch	0.267(H) $\times$ 0.270(V)	mm
Pixel configuration	R,G,B vertical stripe	
Display mode	Normally white	
Unit outline dimensions *1	216.0(W) $\times$ 152.4(H) $\times$ 12.0(D)	mm
Mass	410 $\pm$ 20	g
Surface treatment	Anti-glare and hard-coating 3H Haze value = 28%	

\*1.Note: excluding backlight cables and mounting tabs.

Outline dimensions is shown in Fig.1

### 4. Input Terminals

#### 4-1. TFT-LCD panel driving

CN1 Used connector:DF9BA-31P-1V (Hirose Electric Co., Ltd.)

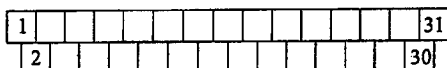

CN1 pin arrangement from module surface  
(transparent view)

Corresponding connector: DF9-31S-1V ( " )  
 DF9A-31S-1V( " )  
 DF9B-31S-1V( " )  
 DF9M-31S-1V( " )

Pin No.	Symbol	Function	Remark
1	GND		
2	CK	Clock signal for sampling each data signal	
3	H sync	Horizontal synchronous signal	【Note1】
4	V sync	Vertical synchronous signal	【Note1】
5	GND		
6	R0	RED data signal(LSB)	
7	R1	RED data signal	
8	R2	RED data signal	
9	R3	RED data signal	
10	R4	RED data signal	
11	R5	RED data signal(MSB)	
12	GND		
13	G0	GREEN data signal(LSB)	
14	G1	GREEN data signal	
15	G2	GREEN data signal	
16	G3	GREEN data signal	
17	G4	GREEN data signal	
18	G5	GREEN data signal(MSB)	
19	GND		
20	B0	BLUE data signal(LSB)	
21	B1	BLUE data signal	
22	B2	BLUE data signal	
23	B3	BLUE data signal	
24	B4	BLUE data signal	
25	B5	BLUE data signal(MSB)	
26	GND		
27	ENAB	Signal to settle the horizontal display position	【Note2】
28	Vcc	+3.3/+5.0V power supply	
29	Vcc	+3.3/+5.0V power supply	
30	R/L	Horizontal display mode select signal	【Note3】
31	U/D	Vertical display mode select signal	【Note4】

※The shielding case is not connected with GND.

【Note1】 480 line, 400 line or 350 line mode  
 is selected by the polarity combination  
 of the both synchronous signals.

Mode	480 lines	400 lines	350 lines
H sync	negative	negative	positive
V sync	negative	positive	negative

【Note2】 The horizontal display start timing is settled in  
 accordance with a rising timing of ENAB signal. In case ENAB is fixed "Low", the horizontal start timing is  
 determined as described in 7-2. Don't keep ENAB "High" during operation.

【Note3】 R/L=High, U/D=High

R/L=Low, U/D=High

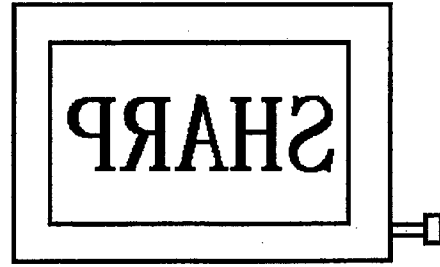
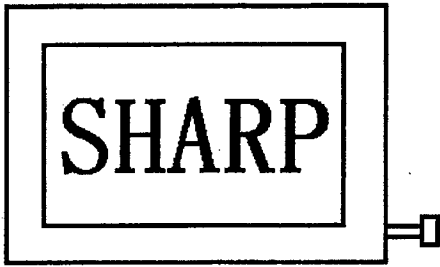

【Note4】 R/L=High, U/D=Low

R/L=Low, U/D=Low

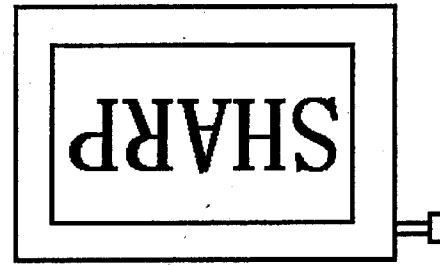
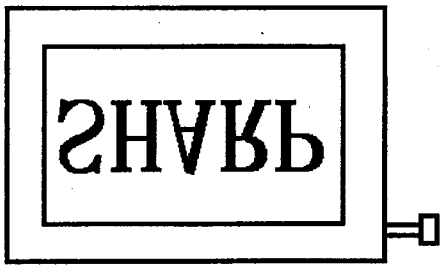

4-2. Backlight driving

Used connector : BHR-03VS-1(JST)

CNA, CNB

Corresponding connector :SM02(8.0)B-BHS(JST)

Pin no.	Symbol	function
1	V <sub>HIGH</sub>	Power supply for lamp (High voltage side)
2	NC	This is electrically opened.
3	V <sub>LOW</sub>	Power supply for lamp (Low voltage side)

5. Absolute Maximum Ratings

Parameter	Symbol	Condition	Ratings	Unit	Remark
Input voltage	V <sub>I</sub>	Ta=25°C	-0.3 ~ V <sub>CC</sub> +0.3	V	【Note1】
supply voltage	V <sub>CC</sub>	Ta=25°C	0 ~ +6	V	-
Storage temperature	T <sub>stg</sub>	-	-25 ~ +70	°C	【Note2】
Operating temperature (Panel)	T <sub>opa</sub>	-	0 ~ +63		
Operating temperature (Ambient)	T <sub>opp</sub>	-	0 ~ +60	°C	

【Note1】 CK,R0~R5,G0~G5,B0~B5,Hsync,Vsync,ENAB, R/L, U/L

【Note2】 Humidity : 95%RH Max. at Ta≤40°C.

Maximum wet-bulb temperature at 39°C or less at Ta>40°C.

No condensation.

6. Electrical Characteristics

6-1. TFT-LCD panel driving

Ta=25°C

Parameter	Symbol	Min.	Typ.	Max.	Unit	Remark
3.3V Supply voltage	V <sub>CC</sub>	+3.0	+3.3	+3.6	V	[Note1]
5.0V Supply voltage	V <sub>CC</sub>	+4.5	+5.0	+5.5	V	
Current dissipation	I <sub>CC</sub>	-	410	460	mA	[Note2]
Permissible input ripple voltage	V <sub>RF</sub>	-	-	100	mVp-p	V <sub>CC</sub> =+3.3V
Input voltage (Low)	V <sub>IL</sub>	-	-	0.3V <sub>CC</sub>	V	
Input voltage (High)	V <sub>IH</sub>	0.7V <sub>CC</sub>	-	-	V	[Note3]
Input current (low)	I <sub>OL1</sub>	-	-	1.0	μA	V <sub>I</sub> =0V [Note4]
	I <sub>OL2</sub>	-	-	60.0	μA	V <sub>I</sub> =0V [Note5]
Input current (High)	I <sub>OH1</sub>	-	-	1.0	μA	V <sub>I</sub> =V <sub>CC</sub> [Note4]
	I <sub>OH2</sub>	-	-	60.0	μA	V <sub>I</sub> =V <sub>CC</sub> [Note5]

[ NOTE 1 ]

V<sub>CC</sub>-turn-on conditions

- 0 < T<sub>1</sub> ≤ 15 ms
- 0 < T<sub>2</sub> ≤ 20 ms
- 0 < T<sub>3</sub> ≤ 1 s
- 1 s < T<sub>4</sub>

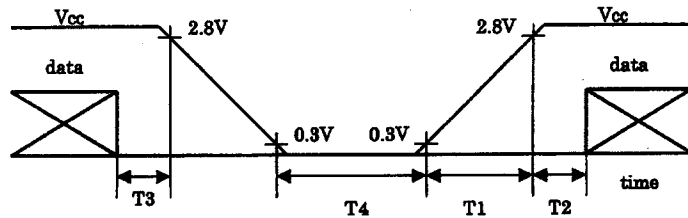

V<sub>CC</sub>-dip conditions

- 1) 2.7V ≤ V<sub>CC</sub> < 3.0V
- t<sub>d</sub> ≤ 10ms
- 2) V<sub>CC</sub> < 2.7V

V<sub>CC</sub>-dip conditions should also follow  
The V<sub>CC</sub>-turn-on conditions

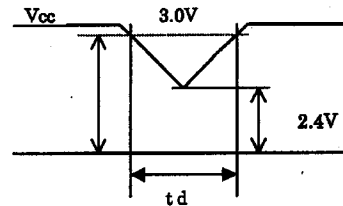

[Note2] Typical current situation : 16-gray-bar pattern.

480 line mode  
V<sub>CC</sub>=+3.3V

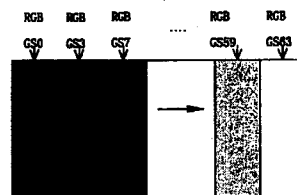

[Note3] CK, R0~R5, G0~G5, B0~B5, Hsync, Vsync, ENAB,  
R/L, U/D

[Note4] CK, R0~R5, G0~G5, B0~B5, Hsync, Vsync, ENAB

[Note5] ENAB, R/L, U/D



6-2. Backlight driving

The backlight system is an edge-lighting type with single CCFT (Cold Cathode Fluorescent Tube). The characteristics of single lamp are shown in the following table.

Ta=25°C						
Parameter	Symbol	Min.	Typ.	Max.	Unit	Remark
Lamp current	IL	2.0	6.0	6.5	mArms	【Note1】
Lamp power consumption	PL	—	4.1	—	W	【Note2】
Lamp frequency	FL	20	45	70	KHz	【Note3】
Kick-off voltage	Vs	—	—	1300	Vrms	Ta=25°C
		—	—	1500	Vrms	Ta=0°C 【Note4】
Lamp life time	LL	—	50000	—	hour	【Note5】

【Note1】 Lamp current is measured with current meter for high frequency as shown below.

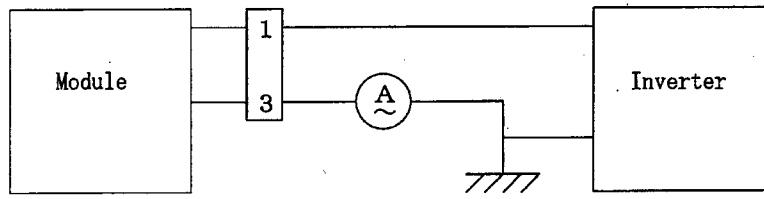

\* 3pin is V LOW

【Note2】 At the condition of  $Y_L = 300\text{cd/m}^2$

【Note3】 Lamp frequency may produce interference with horizontal synchronous frequency, and this may cause beat on the display. Therefore lamp frequency shall be detached as much as possible from the horizontal synchronous frequency and from the harmonics of horizontal synchronous to avoid interference.

【Note4】 The open output voltage of the inverter shall be maintained for more than 1sec; otherwise the lamp may not be turned on.

【Note5】 Since lamp is consumables, the life time written above is referencial value and it is not guaranteed in this specification sheet by SHARP.

Lamp life time is defined that it applied either ① or ② under this condition  
(Continuous turning on at Ta=25°C, IL=6mArms)

- ① Brightness becomes 50% of the original value under standard condition.
- ② Kick-off voltage at Ta=0°C exceeds maximum value, 1500 Vrms.

In case of operating under lower temp environment, the lamp exhaustion is accelerated and the brightness becomes lower. (Continuous operating under for around 1 month under lower temp condition may reduce the brightness to half of the original brightness.)

In case of such usage under lower temp environment, periodical lamp exchange is recommended.

Note) The performance of the backlight, for example life time or brightness, is much influenced by the characteristics of the DC-AC inverter for the lamp. When you design or order the inverter, please make sure that a poor lighting caused by the mismatch of the backlight and the inverter (miss-lighting, flicker, etc.) never occur. when you confirm it, the module should be operated in the same condition as it is installed in your instrument.

Recommended inverter is "CXA-L0612A-VJL(TDK corporation)".

## 7. Timing Characteristics of input signals

Timing diagrams of input signal are shown in Fig.2 - ①~③ .

## 7-1. Timing characteristics

Parameter		Symbol	Mode	Min.	Typ.	Max.	Unit	Remark
Clock	Frequency	1/Tc	all	—	25.18	28.33	MHz	
	High time	Tch	"	5	—	—	ns	
	Low time	Tcl	"	10	—	—	ns	
Data	Setup time	Tds	"	5	—	—	ns	
	Hold time	Tdh	"	10	—	—	ns	
Horizontal sync. signal	Cycle	TH	"	30.00	31.78	—	μs	
			"	750	800	900	clock	
	Pulse width	THp	"	2	96	200	clock	
Vertical sync. signal	Cycle	TV	480	515	525	560	line	
			400	446	449	480	line	
			350	447	449	510	line	
	Pulsewidth	TVp	all	1	—	34	line	
Horizontal display period		THd	"	640	640	640	clock	
Hsync-Clock phase difference		THc	"	10	—	Tc-10	ns	
Hsync-Vsync phase difference		TVh	"	0	—	TH-THp	clock	

Note) In case of lower frequency, the deterioration of display quality, flicker etc., may be occurred.

## 7-2. Horizontal display position

The horizontal display position is determined by ENAB signal and the input data corresponding to the rising edge of ENAB signal is displayed at the left end of the active area.

Parameter		symbol	Min.	Typ.	Max.	Unit	Remark
Enable signal	Setup time	Tes	5	—	Tc-10	ns	
	Pulse width	Tep	2	640	640	clock	
Hsync-Enable signal phase difference		THE	44	—	TH-664	clock	

Note) When ENAB is fixed "Low", the display starts from the data of C104(clock) as shown in Fig.2-①~③. Be careful that the module does not work when ENAB is fixed "High".

7-3. Vertical display position

The vertical display position is automatically centered in the active area at each mode of VGA ,480-,400-, and 350-line mode . Each mode is selected depending on the polarity of the synchronous signals described in 4-1(Note1).

In each mode ,the data of TVn is displayed at the top line of the active area. And the display position will be centered on the screen like the following figure when the period of vertical synchronous signal, TV, is typical value.

In 400-, and 350-line mode, the data in the vertical data invalid period is also displayed, So ,inputting all data "0" is recommended during vertical data invalid period.

ENAB signal has no relation to the vertical display position.

Mode	V-data start(TVs)	V-data period(TVd)	V-display start(TVn)	V-display period	Unit	Remark
480	34	480	34	480	line	
400	34	400	443-TV	480	line	
350	61	350	445-TV	480	line	

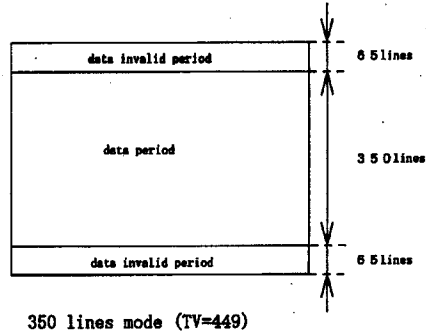
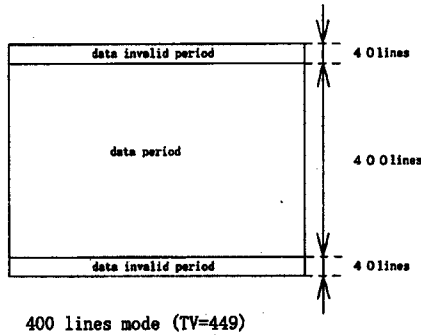

7-4. Input Data Signals and Display Position on the screen

Display position of input data (480 lines mode)  
(H, V)

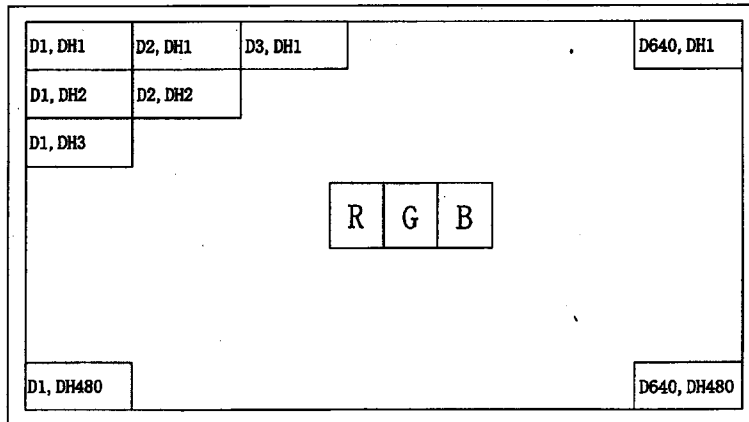

8. Input Signals, Basic Display Colors and Gray Scale of Each Color

	Colors & Gray scale	Data signal																		
		Gray Scale	RA0	RA1	RA2	RA3	RA4	RA5	GA0	GA1	GA2	GA3	GA4	GA5	BA0	BA1	BA2	BA3	BA4	BA5
			RB0	RB1	RB2	RB3	RB4	RB5	GB0	GB1	GB2	GB3	GB4	GB5	BB0	BB1	BB2	BB3	BB4	BB5
Basic Color	Black	—	0	0	0	0	0	0	0	0	0	0	0	0	0	0	0	0	0	0
	Blue	—	0	0	0	0	0	0	0	0	0	0	0	0	1	1	1	1	1	1
	Green	—	0	0	0	0	0	0	1	1	1	1	1	1	0	0	0	0	0	0
	Cyan	—	0	0	0	0	0	0	1	1	1	1	1	1	1	1	1	1	1	1
	Red	—	1	1	1	1	1	1	0	0	0	0	0	0	0	0	0	0	0	0
	Magenta	—	1	1	1	1	1	1	0	0	0	0	0	0	1	1	1	1	1	1
	Yellow	—	1	1	1	1	1	1	1	1	1	1	1	1	0	0	0	0	0	0
	White	—	1	1	1	1	1	1	1	1	1	1	1	1	1	1	1	1	1	1
Gray Scale of Red	Black	GS0	0	0	0	0	0	0	0	0	0	0	0	0	0	0	0	0	0	0
	↑	GS1	1	0	0	0	0	0	0	0	0	0	0	0	0	0	0	0	0	0
	Darker	GS2	0	1	0	0	0	0	0	0	0	0	0	0	0	0	0	0	0	0
	↑	↓			↓					↓					↓					
	↓	↓			↓					↓					↓					
	Brighter	GS61	1	0	1	1	1	1	0	0	0	0	0	0	0	0	0	0	0	0
	↓	GS62	0	1	1	1	1	1	0	0	0	0	0	0	0	0	0	0	0	0
	Red	GS63	1	1	1	1	1	1	0	0	0	0	0	0	0	0	0	0	0	0
Gray Scale of Green	Black	GS0	0	0	0	0	0	0	0	0	0	0	0	0	0	0	0	0	0	0
	↑	GS1	0	0	0	0	0	0	1	0	0	0	0	0	0	0	0	0	0	0
	Darker	GS2	0	0	0	0	0	0	0	1	0	0	0	0	0	0	0	0	0	0
	↑	↓			↓					↓					↓					
	↓	↓			↓					↓					↓					
	Brighter	GS61	0	0	0	0	0	0	1	0	1	1	1	1	0	0	0	0	0	0
	↓	GS62	0	0	0	0	0	0	0	1	1	1	1	1	0	0	0	0	0	0
	Green	GS63	0	0	0	0	0	0	1	1	1	1	1	1	0	0	0	0	0	0
Gray Scale of Blue	Black	GS0	0	0	0	0	0	0	0	0	0	0	0	0	0	0	0	0	0	0
	↑	GS1	0	0	0	0	0	0	0	0	0	0	0	0	1	0	0	0	0	0
	Darker	GS2	0	0	0	0	0	0	0	0	0	0	0	0	0	1	0	0	0	0
	↑	↓			↓					↓					↓					
	↓	↓			↓					↓					↓					
	Brighter	GS61	0	0	0	0	0	0	0	0	0	0	0	0	1	0	1	1	1	1
	↓	GS62	0	0	0	0	0	0	0	0	0	0	0	0	0	1	1	1	1	1
	Blue	GS63	0	0	0	0	0	0	0	0	0	0	0	0	1	1	1	1	1	1

0 :Low level voltage, 1 : High level voltage

Each basic color can be displayed in 64 gray scales from 6 bit data signals. According to the combination of total 18 bit data signals, the 262,144-color display can be achieved on the screen.

9. Optical Characteristics

Ta=25°C, Vcc=+5V

Parameter		Symbol	Condition	Min	Typ	Max	Unit	Remark
Viewing Angle Range	Horizontal	$\theta 21, \theta 22$	$CR \geq 10$	45	55	—	Deg.	【Note 1, 4】
	Vertical	$\theta 11$		45	55	—	Deg.	
		$\theta 12$		30	40	—	Deg.	
Contrast ratio		CR	Best Viewing Angle	—	250	—	—	【Note 2, 4】
Response Time	Rise	$\tau r$	$\theta = 0^\circ$	—	20	—	ms	【Note 3, 4】
	Decay	$\tau d$		—	40	—	ms	
Chromaticity of White		x		—	0.319	—		【Note4】
		y		—	0.329	—		
Luminance of white		$Y_L$		240	300	—	cd/m <sup>2</sup>	
White Uniformity		$\delta w$		—	—	1.45	—	【Note5】
Viewing Angle range as a Brightness Definition	Horizontal	$\theta 21, \theta 22$	50% of the maximum brightness	—	45	—	Deg.	【Note1】
	Vertical	$\theta 11$		—	30	—	Deg.	
		$\theta 12$		—	35	—	Deg.	

※The measurement shall be executed 30 minutes after lighting at rating. (typical condition:  $I_L=6.0mA_{rms}$ )

The optical characteristics shall be measured in a dark room or equivalent state with the method shown in Fig.3 below.

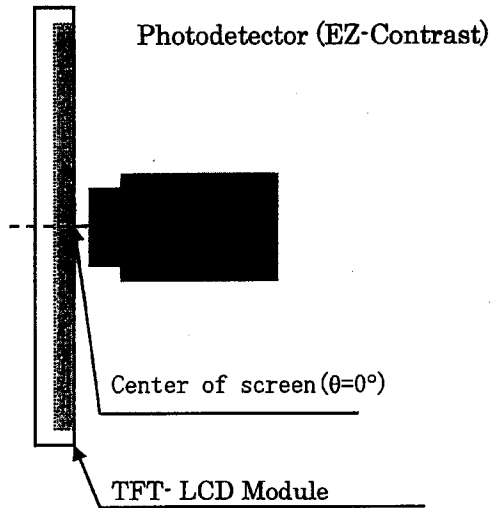

Fig.3-1 Measurement Method  
 ( • Viewing angle range  
 • Response time )

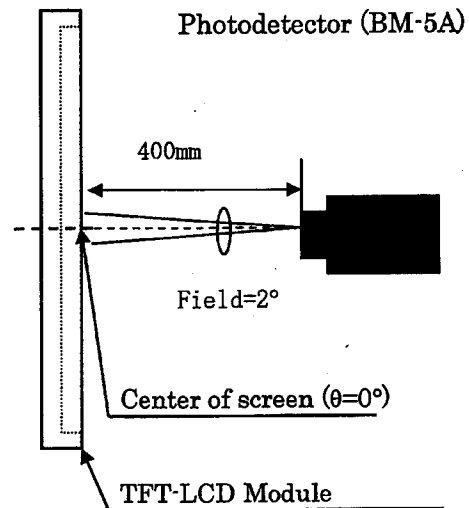
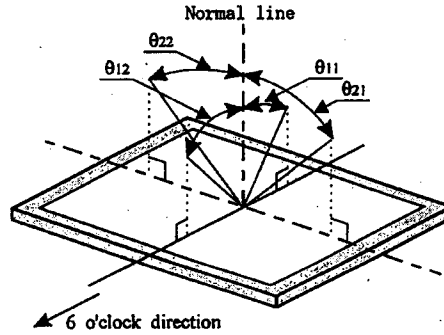

Fig.3-2 Measurement Method  
 ( • Luminance  
 • Contrast ratio  
 • Chromaticity )

**[Note1]** Definitions of viewing angle range:



**[Note2]** Definition of contrast ratio:

The contrast ratio is defined as the following.

$$\text{Contrast Ratio (CR)} = \frac{\text{Luminance (brightness) with all pixels white}}{\text{Luminance (brightness) with all pixels black}}$$

**[Note3]** Definition of response time:

The response time is defined as the following figure and shall be measured by switching the input signal for "black" and "white".

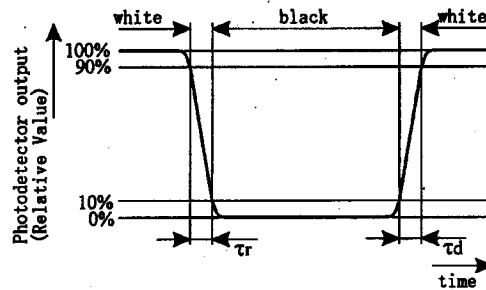

**[Note4]** This shall be measured at center of the screen.

**[Note5]** Definition of white uniformity:

White uniformity is defined as the following with five measurements (A~E).

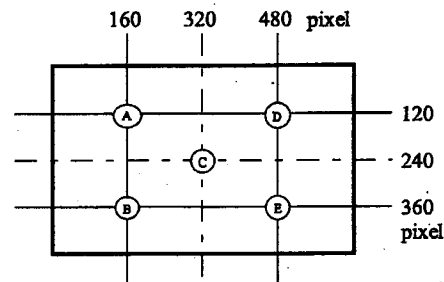

$$\delta_w = \frac{\text{Maximum Luminance of five points (brightness)}}{\text{Minimum Luminance of five points (brightness)}}$$

## 10. Display Quantity

The display quality of the color TFT-LCD module shall be in compliance with the Incoming Inspection Standard.

## 11. Handling Precautions

- a) Be sure to turn off the power supply when inserting or disconnecting the cable.
- b) Be sure to design the cabinet so that the module can be installed without any extra stress such as warp or twist.
- c) Since the front polarizer is easily damaged, pay attention not to scratch it.
- d) Wipe off water drop immediately. Long contact with water may cause discoloration or spots.
- e) When the panel surface is soiled, wipe it with absorbent cotton or other soft cloth.
- f) Since the panel is made of glass, it may break or crack if dropped or bumped on hard surface.  
Handle with care.
- g) Since CMOS LSI is used in this module, take care of static electricity and injure the human earth when handling.
- h) Observe all other precautionary requirements in handling components.
- i) This module has its circuitry PCBs on the rear side and should be carefully handled in order not to be stressed.
- j) Laminated film is attached to the module surface to prevent it from being scratched. Peel the film off slowly, just before the use, with strict attention to electrostatic charges. Ionized air shall be blown over during the action. Blow off 'dust' on the polarizer by using an ionized nitrogen gun etc.
- k) The polarizer surface on the panel is treated with Anti-Glare for low reflection. In case of attaching protective board over the LCD. Be careful about the optical interface fringe etc.  
Which degrades display quality.
- l) Connect GND to 4 place of mounting holes to stabilize against EMI and external noise.
- m) There are high voltage portions on the backlight and very dangerous. Careless touch may lead to electrical shock. When exchange lamps or service. Turn off the power without fail.
- n) Be sure not to apply tensile stress to the lamp lead cable.

## 12. Packing form

- a) Piling number of cartons : MAX 8
- b) Package quantity in one carton : 20 pcs
- c) Carton size : 483(W) × 275(D) × 330(H) mm
- d) Total mass of 1 carton filled with full modules : 10.5kg

13. Reliability test items

No.	Test item	Conditions
1	High temperature storage test	Ta=70°C 240h
2	Low temperature storage test	Ta=-25°C 240h
3	High temperature & high humidity operation test	Ta=40°C ; 95%RH 240h (No condensation)
4	High temperature operation test(Ambient)	Ta=60°C 240h
5	Low temperature operation test(Ambient)	Ta=0°C 240h
6	Vibration test (non- operating)	Frequency : 10~57Hz/Vibration width (one side):0.075mm : 58~500Hz/Gravity:9.8m/s <sup>2</sup> Sweep time : 11 minutes Test period : 3 hours (1 hour for each direction of X,Y,Z)
7	Shock test (non- operating)	Max. gravity : 490m/s <sup>2</sup> Pulse width : 11ms, half sine wave Direction : ±X,±Y,±Z once for each direction.

**【Result Evaluation Criteria】**

Under the display quality test conditions with normal operation state, these shall be no change which may affect practical display function.

14. Others

1) Lot No Label:

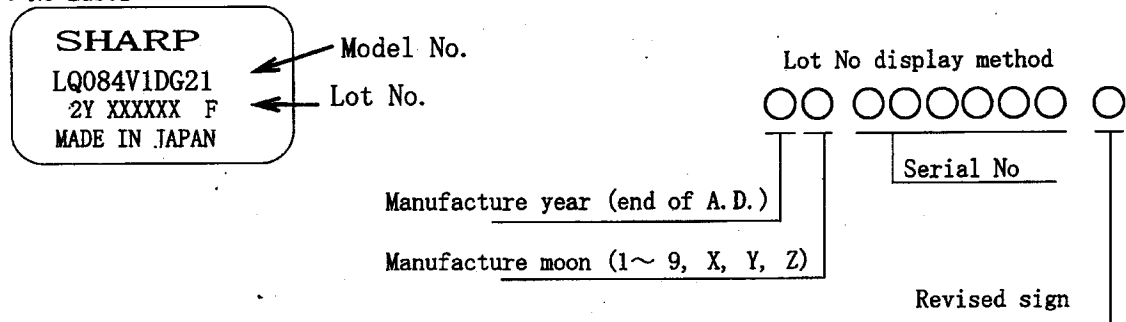

2) Adjusting volume have been set optimally before shipment, so do not change any adjusted value.

If adjusted value is changed, the specification may not be satisfied.

3) Disassembling the module can cause permanent damage and should be strictly avoided.

4) Please be careful since image retention may occur when a fixed pattern is displayed for a long time

5) Do not use LCD module in the atmosphere of corrosive gases, such as sulfide gas or chlorine gases.

Polarizer may deteriorated or cause chemical reaction that can lead to short circuits at the terminal Points. Do not use the material, which compounds contain sulfide or chlorine articles in the vicinity of LCD module. At high temperature, these compounds produce corrosive gases.

6) If any problem occurs in relation to the description of this specification , it shall be resolved through discussion with spirit of cooperation.



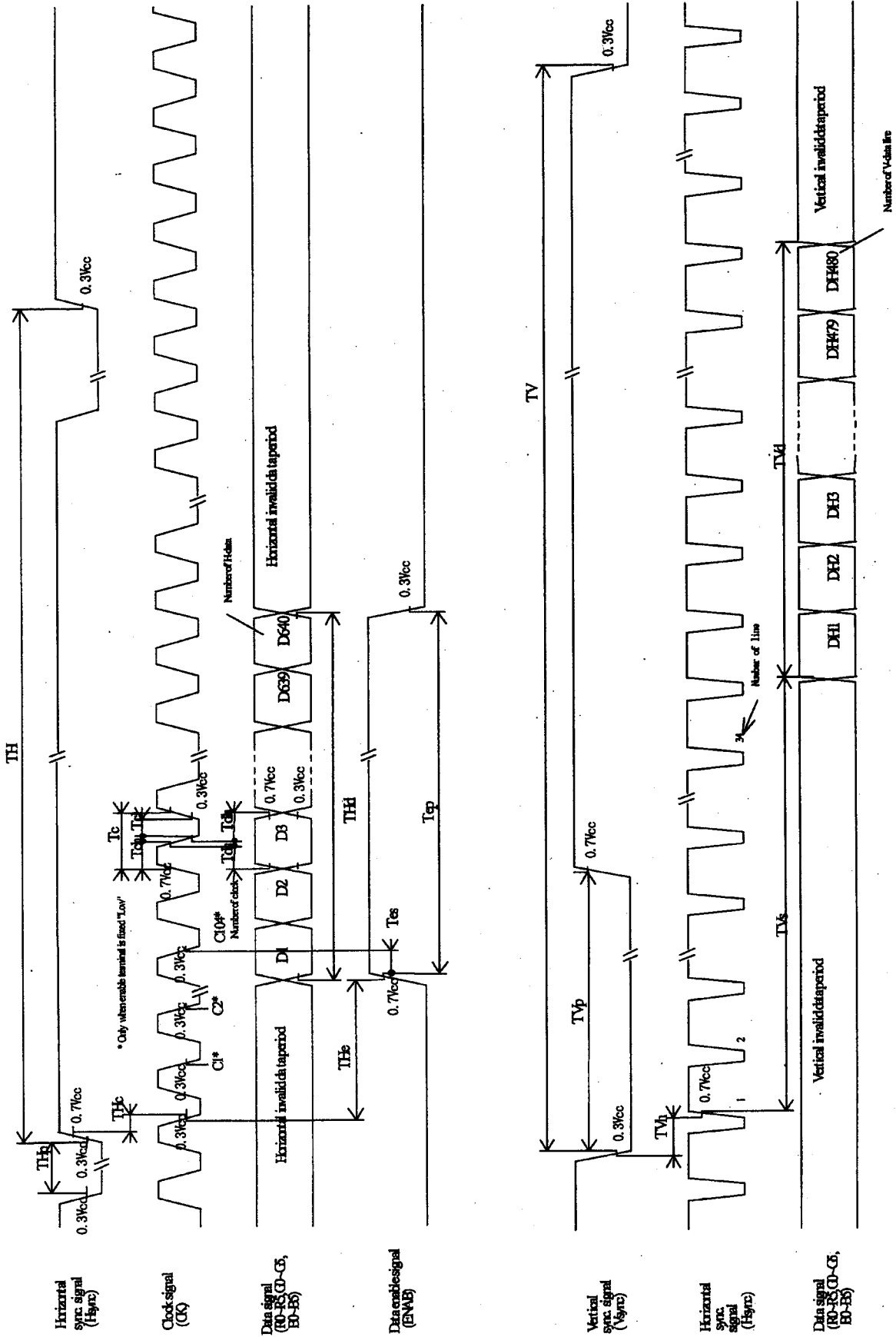

Fig 2-1 Input signal waveforms (480 line mode)



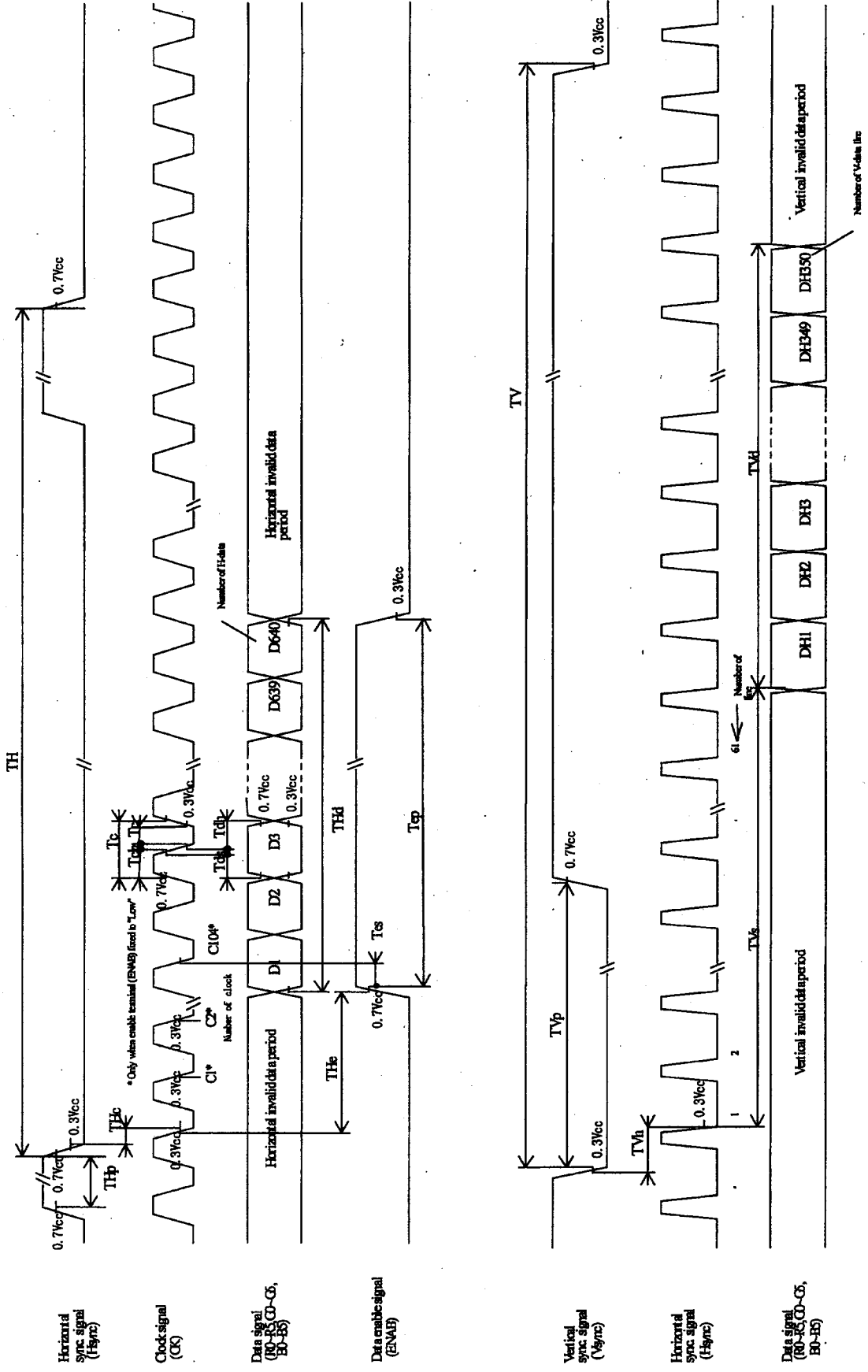
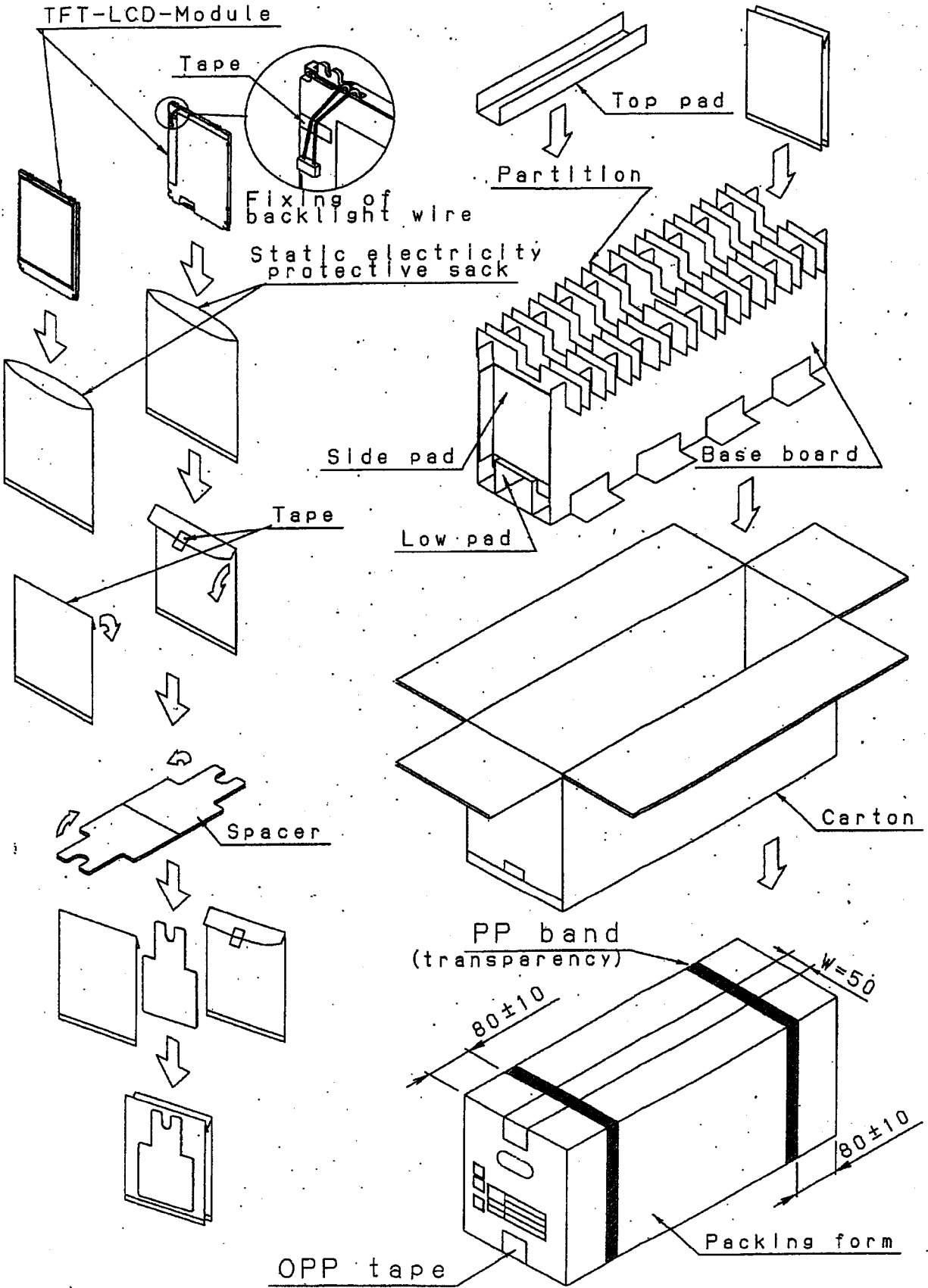
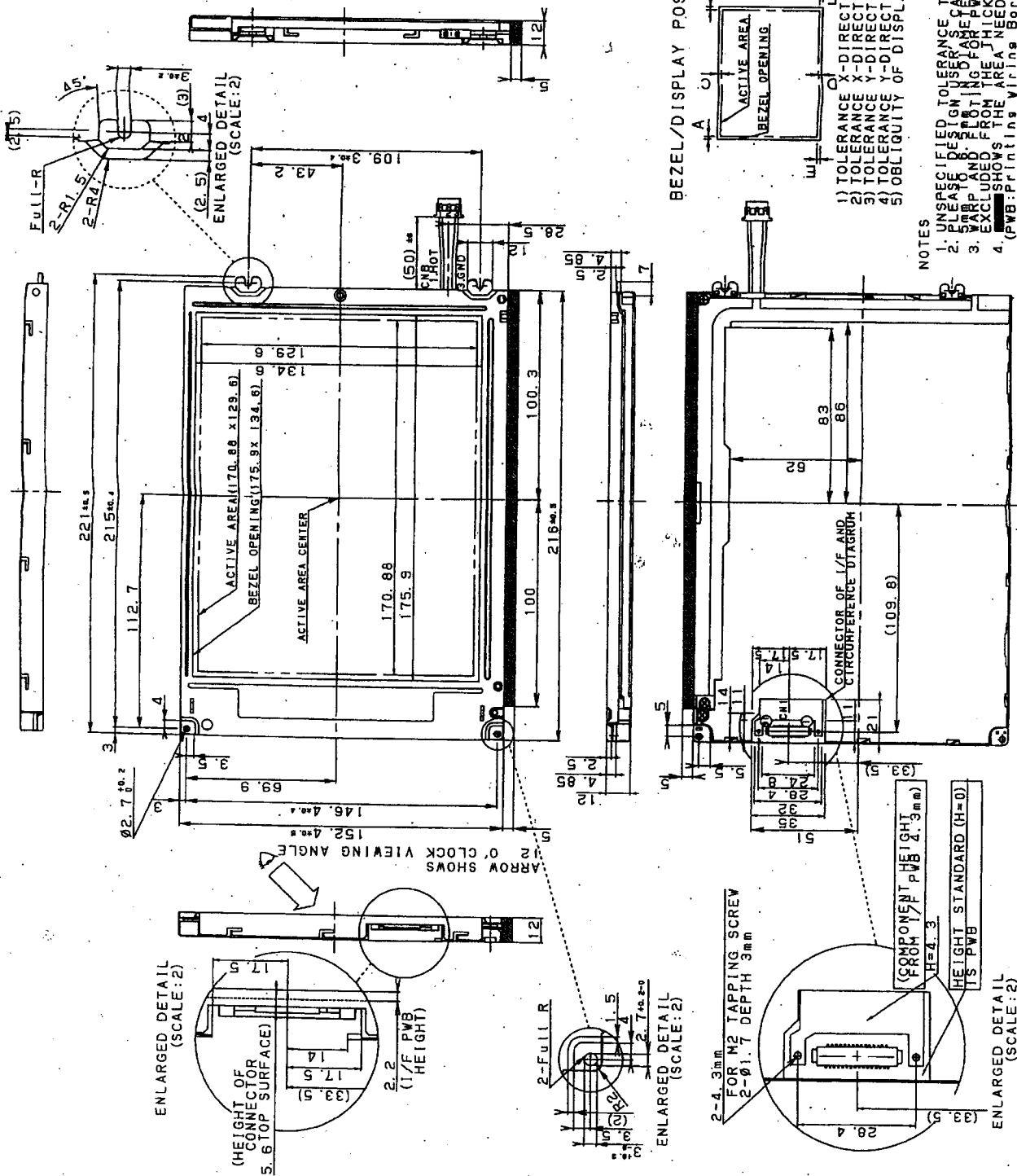

Fig.2-3 Input signal waveforms (350 line mode)





- NOTES
1. UNspecified TOLERANCE TO BE  $\pm 0.5$
  2. PLEASE DESIGN USER'S CABINET BOSSES WITH 2.5mm AND 5mm FLATTING FOR PWB, AND CHASSIS ARE EXCLUDED FROM THE THICKNESS OF THE UNIT.
  3. 5mm AND 5mm FLATTING FOR PWB, AND CHASSIS ARE EXCLUDED FROM THE THICKNESS OF THE UNIT.
  4. SHOWS THE AREA NEEDED FOR LAMP EXCHANGE. (PWB: Printing Viring Board)
- 1) TOLERANCE X-DIRECTION A:  $2.51 \pm 0.8$   
 2) TOLERANCE X-DIRECTION B:  $2.51 \pm 0.8$   
 3) TOLERANCE Y-DIRECTION C:  $2.51 \pm 0.8$   
 4) TOLERANCE Y-DIRECTION D:  $2.51 \pm 0.8$   
 5) OBLIQUITY OF DISPLAY AREA 1E-F  $< 0.8$

FIG1. LQ084V1DG21 OUTLINE DIMENSIONS

**SPECIFICATIONS ARE SUBJECT TO CHANGE WITHOUT NOTICE.**

Suggested applications (if any) are for standard use; See Important Restrictions for limitations on special applications. See Limited Warranty for SHARP's product warranty. The Limited Warranty is in lieu, and exclusive of, all other warranties, express or implied. ALL EXPRESS AND IMPLIED WARRANTIES, INCLUDING THE WARRANTIES OF MERCHANTABILITY, FITNESS FOR USE AND FITNESS FOR A PARTICULAR PURPOSE, ARE SPECIFICALLY EXCLUDED. In no event will SHARP be liable, or in any way responsible, for any incidental or consequential economic or property damage.

---

# SHARP®

## **NORTH AMERICA**

---

SHARP Microelectronics of the Americas  
5700 NW Pacific Rim Blvd.  
Camas, WA 98607, U.S.A.  
Phone: (1) 360-834-2500  
Fax: (1) 360-834-8903  
Fast Info: (1) 800-833-9437  
www.sharpsma.com

## **EUROPE**

---

SHARP Microelectronics Europe  
Division of Sharp Electronics (Europe) GmbH  
Sonninstrasse 3  
20097 Hamburg, Germany  
Phone: (49) 40-2376-2286  
Fax: (49) 40-2376-2232  
www.sharpsme.com

## **JAPAN**

---

SHARP Corporation  
Electronic Components & Devices  
22-22 Nagaike-cho, Abeno-Ku  
Osaka 545-8522, Japan  
Phone: (81) 6-6621-1221  
Fax: (81) 6117-725300/6117-725301  
www.sharp-world.com

## **TAIWAN**

---

SHARP Electronic Components  
(Taiwan) Corporation  
8F-A, No. 16, Sec. 4, Nanking E. Rd.  
Taipei, Taiwan, Republic of China  
Phone: (886) 2-2577-7341  
Fax: (886) 2-2577-7326/2-2577-7328

## **SINGAPORE**

---

SHARP Electronics (Singapore) PTE., Ltd.  
438A, Alexandra Road, #05-01/02  
Alexandra Technopark,  
Singapore 119967  
Phone: (65) 271-3566  
Fax: (65) 271-3855

## **KOREA**

---

SHARP Electronic Components  
(Korea) Corporation  
RM 501 Geosung B/D, 541  
Dohwa-dong, Mapo-ku  
Seoul 121-701, Korea  
Phone: (82) 2-711-5813 ~ 8  
Fax: (82) 2-711-5819

## **CHINA**

---

SHARP Microelectronics of China  
(Shanghai) Co., Ltd.  
28 Xin Jin Qiao Road King Tower 16F  
Pudong Shanghai, 201206 P.R. China  
Phone: (86) 21-5854-7710/21-5834-6056  
Fax: (86) 21-5854-4340/21-5834-6057

### **Head Office:**

No. 360, Bashen Road,  
Xin Development Bldg. 22  
Waigaoqiao Free Trade Zone Shanghai  
200131 P.R. China  
Email: smc@china.global.sharp.co.jp

## **HONG KONG**

---

SHARP-ROXY (Hong Kong) Ltd.  
3rd Business Division,  
17/F, Admiralty Centre, Tower 1  
18 Harcourt Road, Hong Kong  
Phone: (852) 28229311  
Fax: (852) 28660779  
www.sharp.com.hk

### **Shenzhen Representative Office:**

Room 13B1, Tower C,  
Electronics Science & Technology Building  
Shen Nan Zhong Road  
Shenzhen, P.R. China  
Phone: (86) 755-3273731  
Fax: (86) 755-3273735

# Mouser Electronics

Authorized Distributor

Click to View Pricing, Inventory, Delivery & Lifecycle Information:

[Sharp Microelectronics:](#)

[LQ084V1DG21](#)